

4/4 directional control valves, direct operated,
with electrical position feedback and integrated
electronics (OBE)

Type 4WRPEH

RE 29121

Edition: 2014-01

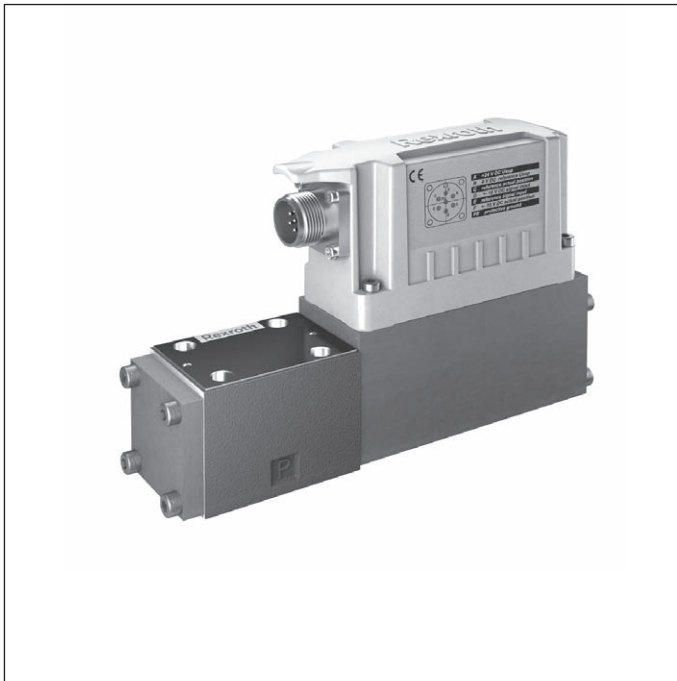

- ▶ Size 6
- ▶ Component series 3X
- ▶ Maximum operating pressure 350 bar
- ▶ Rated flow 4...40 l/min ($\Delta p = 70$ bar)



Features

- ▶ Reliable - proven and robust design
- ▶ Safe - fail-safe position of the control spool in switched-off condition
- ▶ Energy-efficient - no pilot oil demand
- ▶ High quality - control spool and sleeve in servo quality
- ▶ Flexible - suitable for position, velocity and pressure control
- ▶ Precise - high response sensitivity and little hysteresis

Contents





Features	1
Ordering code	2, 3
Symbols	3
Function, section	4
Technical data	5, 6
Block diagram/controller function block	7
Electrical connections, assignment	7
Characteristic curves	8 ... 10
Dimensions	11
Accessories, additional information	12

Ordering code

01	02	03	04	05	06	07	08	09	10	11	12	13	14	
4	WRP	E	H	6		B			-	3X	/	/	24	*

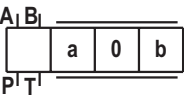
01	4 main ports	4
02	High-response valve, direct operated	WRP
03	With integrated electronics	E
04	Control spool/sleeve	H
05	Size 6	6

Control spool symbols

06	Symbol	Flow characteristics L	Flow characteristics P	
				
		●	●	C
		●	●	C1 ¹⁾
		●	●	C4
		●	●	C3
		●	●	C5 ¹⁾
	¹⁾ With symbols C1 and C5: P → A: q_{Vnom} B → T: $q_{Vnom} / 2$ P → B: $q_{Vnom} / 2$ A → T: q_{Vnom} q_{Vnom} 2:1 only with rated flow = 40 l/min			

07	Installation side of the inductive position transducer	B
----	--	----------

Rated flow of size 6 with 70 bar valve pressure differential (35 bar/control edge)

08		Flow characteristics L	Flow characteristics P	
	04 l/min	●	● (inflection at 40 %)	04
	12 l/min	●		12
	15 l/min		● (inflection at 60 %)	15
	24 l/min	●		24
	25 l/min		● (inflection at 60 %)	25
	40 l/min	●	● (inflection at 40 %)	40

● = Delivery range

Flow characteristics

09	Linear	L
	Inflected characteristic curve, linear	P

10	Component series 30 ... 39 (30 ... 39: Unchanged installation and connection dimensions)	3X
----	--	-----------

Seal material

11	NBR seals	M
	FKM seals	V

Ordering code





01	02	03	04	05	06	07	08	09	10	11	12	13	14	
4	WRP	E	H	6		B			-	3X	/	/	24	*

12	Supply voltage of the integrated electronics: 24 VDC	24
----	--	-----------

Interfaces of the control electronics

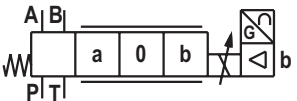
13	Command value input ±10 V	A1
	Command value input 4 ... 20 mA	F1
14	Further details in the plain text	

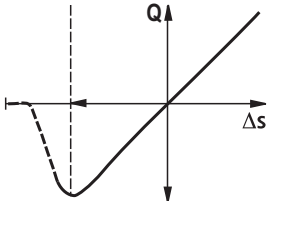
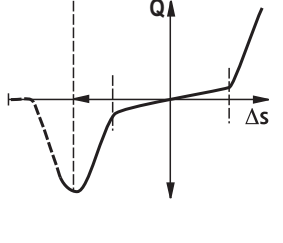
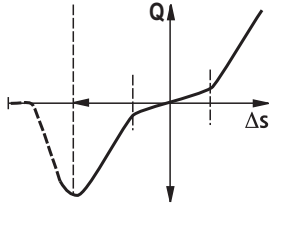
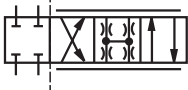
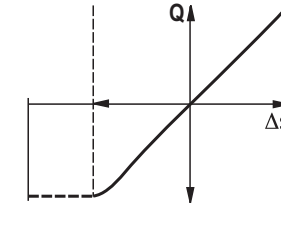
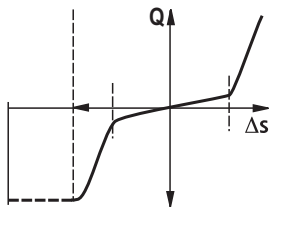
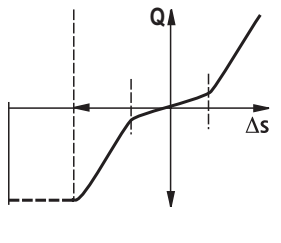
Symbols

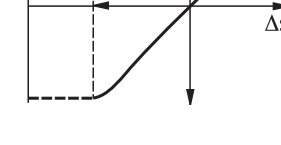
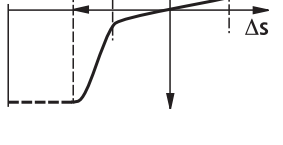
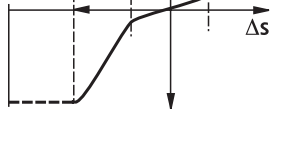
	Linear	P: Inflection 60 % [$q_{Vnom} = 15.25$ l/min]	P: Inflection 40 %
 C3, C5			
 C4, C1			
 C			
Standard = 1:1, q_{Vnom} 2:1 only with rated flow = 40 l/min			

Function, section

Set-up

The 4WRPEH high-response valve mainly consists of:

- ▶ Valve housing with control spool and sleeve in servo quality (1)
- ▶ Control solenoid with position transducer (2)
- ▶ On-board electronics (OBE) (3) with analog interface (4)

Failure of supply voltage

If the supply voltage fails or if the minimum supply voltage is no longer achieved as well as in case of cable break, the integrated electronics will de-energize the control solenoid, the control spool will take the fail-safe position.

Functional description

The 4WRPEH is a direct operated directional control valve with electrical position feedback and integrated electronics (OBE). The integrated electronics (OBE) compares the specified command value to the actual position value.

In case of control deviations, the stroke solenoid will be activated. Due to the changed magnetic force, the control spool is adjusted against the spring. Stroke/control spool cross-section is controlled proportionally to the command value. In case of a command value presetting of 0 V, the electronics adjusts the control spool against the spring to central position. In deactivated condition, the spring is untensioned to a maximum and the valve is in fail-safe position.

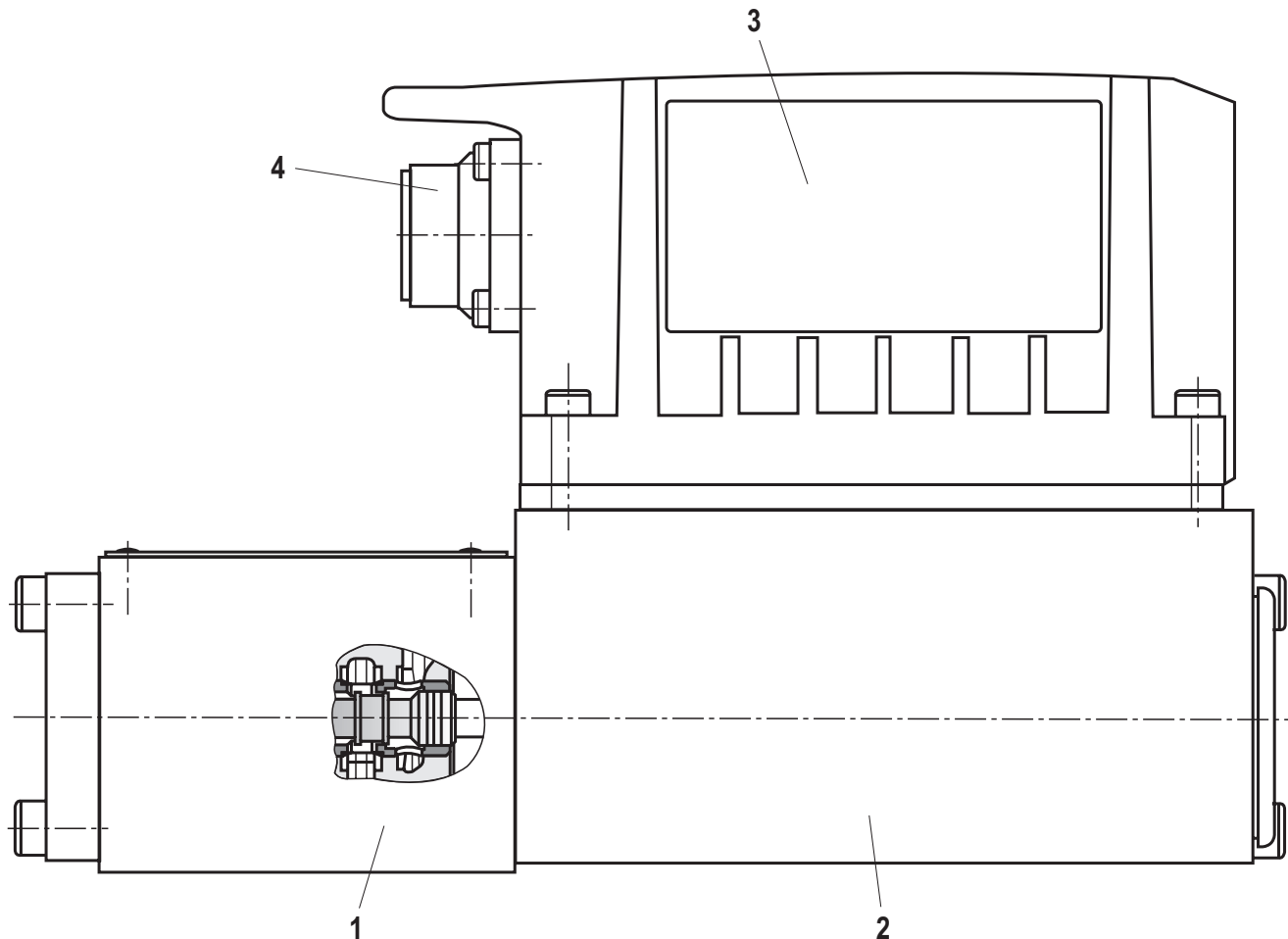

Technical data

(For applications outside these parameters, please consult us!)

general	
Design	Spool valve, direct operated, with steel sleeve
Actuation	Proportional solenoid with position control, OBE
Type of connection	Subplate mounting, porting pattern according to ISO 4401
Installation position	Any
Ambient temperature range	°C -20 ... +60
Storage temperature range with UV protection	°C +10 ... +40
Transport temperature	°C -30 ... +80
Sine test according to DIN EN 60068-2-6	10...2000 Hz / maximum of 10 g / 10 cycles / 3 axes
Noise test according to DIN EN 60068-2-64	20...2000 Hz / 10 g _{RMS} / 30 g peak / 30 min / 3 axes
Transport shock according to DIN EN 60068-2-27	15g / 11 ms / 3 axes
Weight	kg 2.9
Maximum relative humidity (no condensation)	% 95
Maximum solenoid surface temperature	°C 150
MTTFd value according to EN ISO 13849	Years 150 (for further details see data sheet 08012)

hydraulic	
Hydraulic fluid	See table on page 6
Viscosity range	- recommended mm ² /s 20 ... 100
	- maximum admissible mm ² /s 10 ... 800
Hydraulic fluid temperature range (flown-through)	°C -20 ... +70
Maximum admissible degree of contamination of the hydraulic fluid, cleanliness class according to ISO 4406 (c)	Class 18/16/13 ¹⁾

Rated flow at $\Delta p = 35$ bar per edge ²⁾	l/min	4	12	15	24/25	40
Maximum operating pressure	- Ports A, B, P bar	350				
	- Port T bar	250				
Limitation of use with regard to the transition to failsafe (values apply to summed edge)	- Spool symbols C3, C5, C bar	350	350	350	350	160
	- Spool symbols C1, C4 bar	350	350	280	250	100
Leakage flow at 100 bar	- Linear characteristic curve L cm ³ /min	< 180	< 300	-	< 500	< 900
	- Inflected characteristic curve P cm ³ /min	< 150	-	< 180	< 300	< 450

static/dynamic	
Hysteresis	% < 0.1
Range of inversion	% < 0.05
Response sensitivity	% < 0.05
Manufacturing tolerance q_{Vmax}	% < 10
Temperature drift (temperature range 20 °C ... 80 °C)	Zero shift < 0.25 % with $\Delta\theta = 10$ K
Pressure drift	%/100 bar Zero shift < 0.15
Zero compensation	Ex factory ± 1 %

¹⁾ The cleanliness classes specified for the components must be adhered to in hydraulic systems. Effective filtration prevents faults and at the same time increases the life cycle of the components.

For the selection of the filters see www.boschrexroth.com/filter.

²⁾ Flow with different Δp :

$$q_x = q_{Vnom} \cdot \sqrt{\frac{\Delta p_x}{35}}$$

Technical data

(For applications outside these parameters, please consult us!)

Hydraulic fluid	Classification	Suitable sealing materials	Standards
Mineral oils and related hydrocarbons	HL, HLP, HLPD, HVLP, HVLPD	NBR, FKM	DIN 51524
Bio-degradable – insoluble in water	HETG	NBR, FKM	ISO 15380
	HEES	FKM	
– soluble in water	HEPG	FKM	ISO 15380
Flame-resistant – water-free	HFDU, HFDR	FKM	ISO 12922
	HFC (Fuchs HYDROTHERM 46M, Petrofer Ultra Safe 620)	NBR	ISO 12922

 **Important information on hydraulic fluids!**

- ▶ There may be limitations regarding the technical valve data (temperature, pressure range, life cycle, maintenance intervals, etc.)!
- ▶ The flash point of the hydraulic fluid used must be 40 K higher than the maximum solenoid surface temperature.
- ▶ **Mineral oils and related hydrocarbons:**
 - If mineral oils and related hydrocarbons are used, data sheet 90220 must be complied with!
- ▶ **Bio-degradable:**
 - If bio-degradable hydraulic fluids are used, data sheet 90221 must be complied with!

▶ **Flame-resistant – water-free:**

- If flame-resistant, water-free hydraulic fluids are used, data sheet 90222 must be complied with!

▶ **Flame-resistant – containing water:** The maximum pressure differential per control edge is 50 bar. Pressure pre-loading at the tank port > 20 % of the pressure differential; otherwise, increased cavitation. Life cycle as compared to operation with mineral oil HL, HLP 50 % to 100 %.

electrical, integrated electronics (OBE)	
Relative duty cycle (%)	100 (continuous operation)
Protection class according to EN 60529	IP 65 with mounted and locked plug-in connectors
Supply voltage	24 V=
Terminal A:	At least 19 V=/maximum 36 V=
Terminal B:	0 V
Maximum admissible residual ripple	2.5 Vpp
Maximum power consumption	40 VA
Fuse protection, external	2.5 A _T
Input, version A1	Differential amplifier, $R_i = 100 \text{ k}\Omega$
Terminal D: U_E	0 ... $\pm 10 \text{ V}$
Terminal E:	0 V
Input, version F1	Load, $R_{sh} = 200 \Omega$
Terminal D: I_{D-E}	4 ... (12) ... 20 mA
Terminal E: I_{D-E}	Current loop I_{D-E} feedback
Maximum voltage of the differential inputs against 0 V	D → B } Maximum 18 V E → B }
Test signal, version A1	LVDT
Terminal F: U_{test}	0 ... $\pm 10 \text{ V}$
Terminal C:	Reference 0 V
Test signal, version F1	LVDT signal 4 ... 20 mA at external load 200 ... 500 Ω maximum
Terminal F: I_{F-C}	4 ... 20 mA output
Terminal C: I_{F-C}	Current loop I_{F-C} feedback
Functional earth and screening	See pin assignment (CE-compliant installation)
Adjustment	Calibrated in the factory, see valve characteristic curve
Conformity	CE according to EMC Directive 2004/108/EC Tested according to EN 61000-6-2 and EN 61000-6-3

Block diagram/controller function block

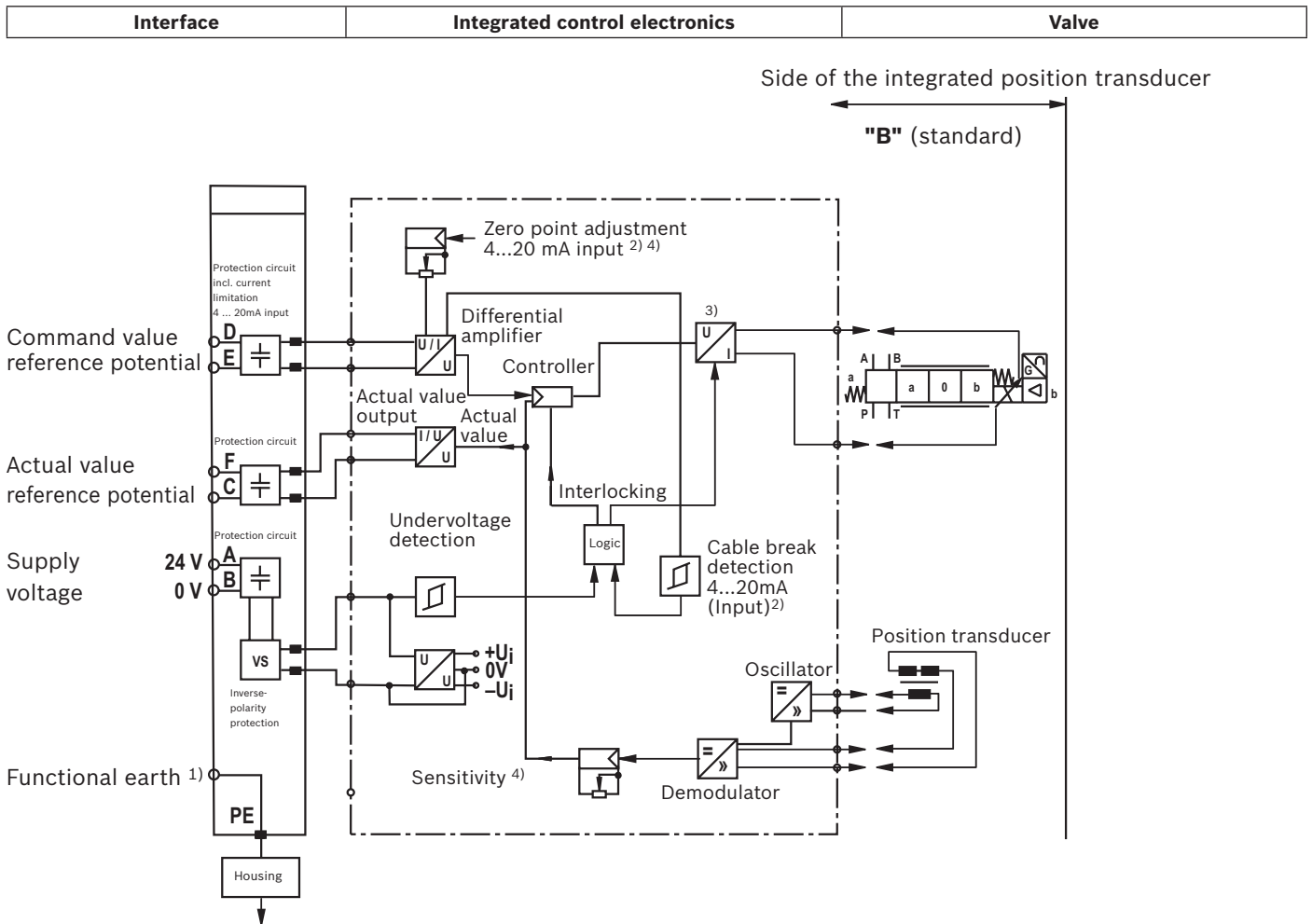

- 1) PE port is connected to the valve housing
- 2) Applies only to F1 interface
- 3) Output stage current-controlled
- 4) Calibrated in the factory

Electrical connections and assignment

Connector pin assignment

Pin	Signal	Assignment interface A1	Assignment interface F1
A	Supply voltage	24 VDC	
B		0 V	
C	Reference potential actual value	Reference potential actual value - pin F	
D	Differential amplifier input	Command value ±10 V	Command value 4 to 20 mA
E		Reference potential command value - pin D	
F	Measuring output (actual value)	Actual value ±10 V	Actual value 4 to 20 mA
PE		Functional earth (directly connected to the valve housing)	

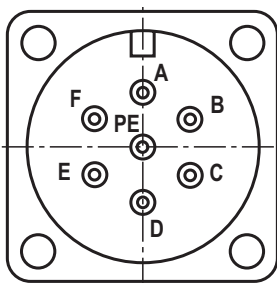

Command value: Positive command value (0 to 10 V or 12 to 20 mA) at D and reference potential at E result in flow from P → A and B → T.
 Negative command value (0 to -10 V or 12 to 4 mA) at D and reference potential at E result in flow from P → B and A → T.

Connection cables: Recommendation: – up to 20 m cable length type LiYCY 7 x 0.75 mm²
 – up to 40 m cable length type LiYCY 7 x 1.0 mm²
 Only connect the screening to PE on the supply side.

Characteristic curves

(measured with HLP46, $\vartheta_{oil} = 40 \pm 5 \text{ }^\circ\text{C}$)

Flow/signal function

L: Linear

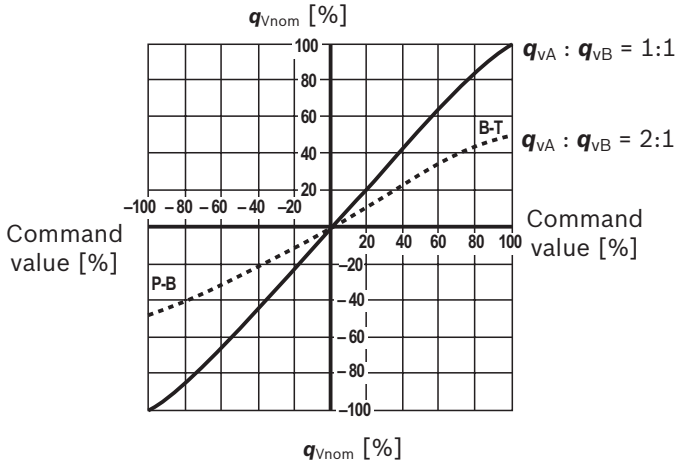

P: Inflection 60 %

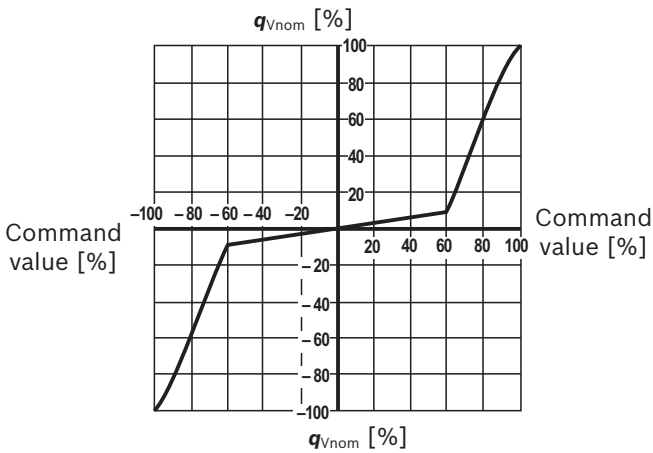

P: Inflection 40 %

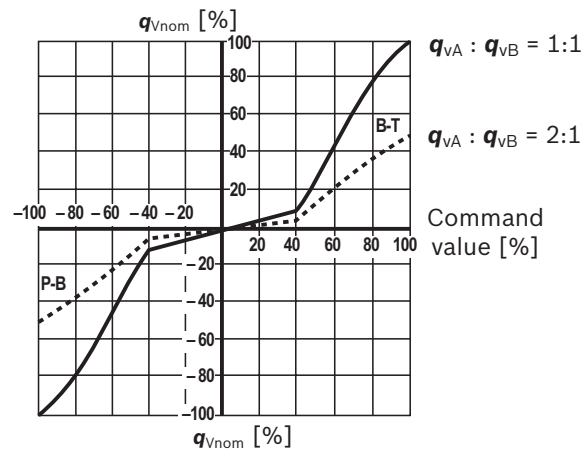

	Fail-safe position			
C3, C5		Leakage flow at	100 bar	P → A 50 cm ³ /min P → B 70 cm ³ /min
		Flow at	$\Delta p = 35 \text{ bar}$	A → T 10 ... 20 l/min B → T 7 ... 20 l/min
C4, C1		Leakage flow at	100 bar	P → A 50 cm ³ /min P → B 70 cm ³ /min
				A → T 70 cm ³ /min B → T 50 cm ³ /min
	Fail-safe	$p = 0 \text{ bar} \Rightarrow 7 \text{ ms}$ $p = 100 \text{ bar} \Rightarrow 10 \text{ ms}$	Internal shut-off in case of error $U_B \leq 17.5 \text{ V}$ and/or $I \leq 2 \text{ mA}$	

Characteristic curves

(measured with HLP46, $\vartheta_{oil} = 40 \pm 5 \text{ }^\circ\text{C}$)

Pressure/signal characteristic curve

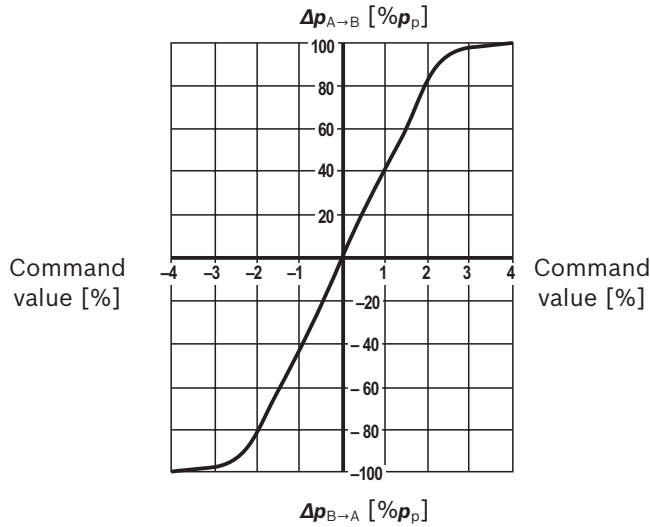

Transition function with stepped electric input signals

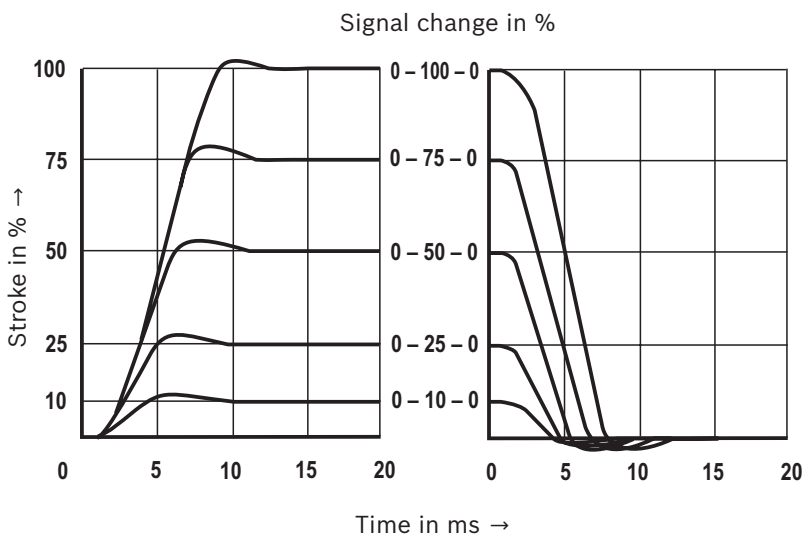

Characteristic curves

(measured with HLP46, $\vartheta_{oil} = 40 \pm 5 \text{ }^\circ\text{C}$)

Frequency response characteristic curves

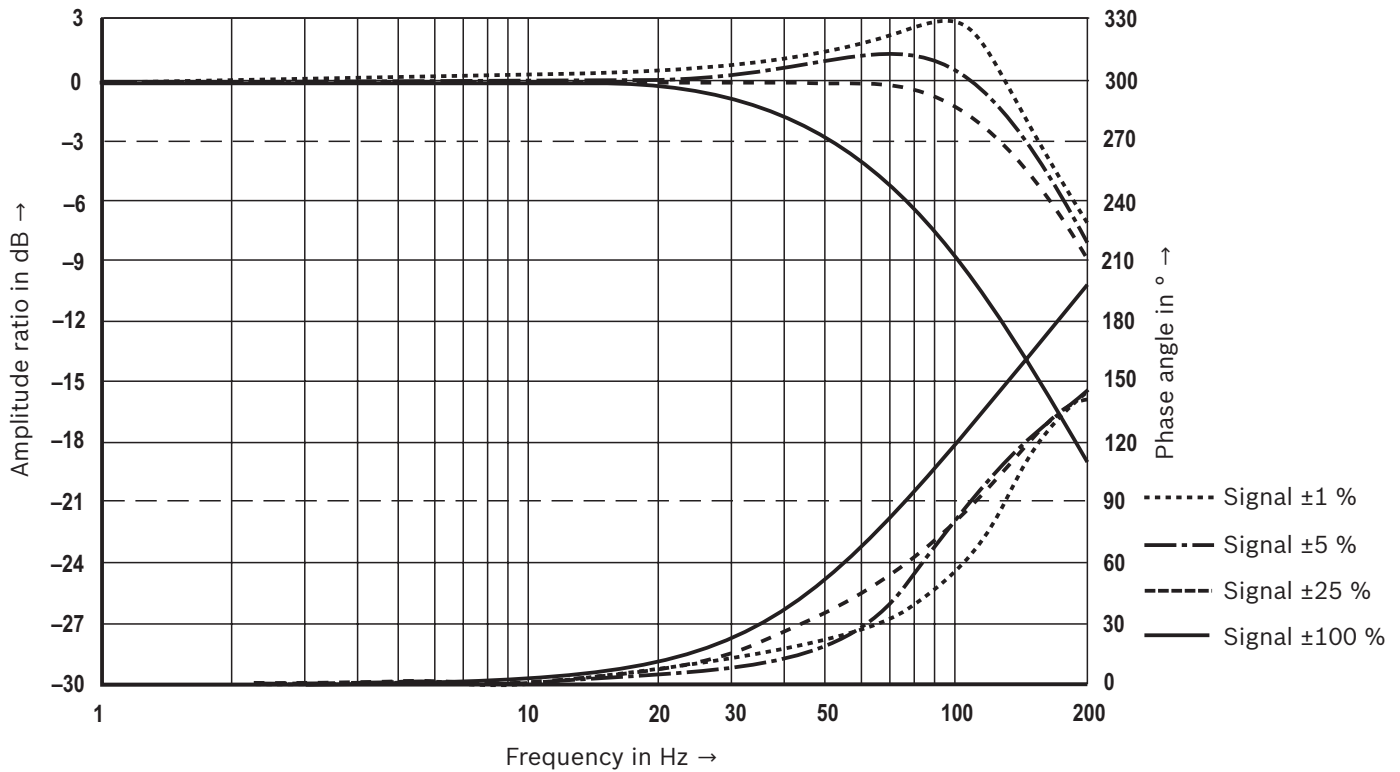

Flow/load function with maximum valve opening

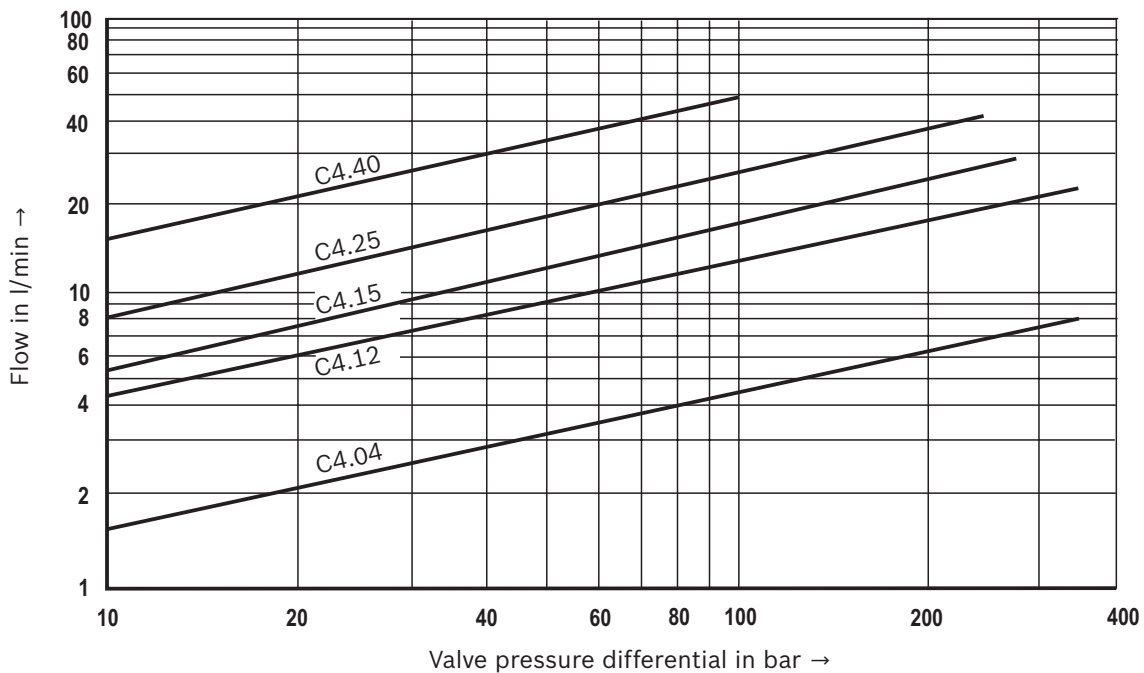

Dimensions (dimensions in mm)

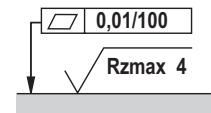
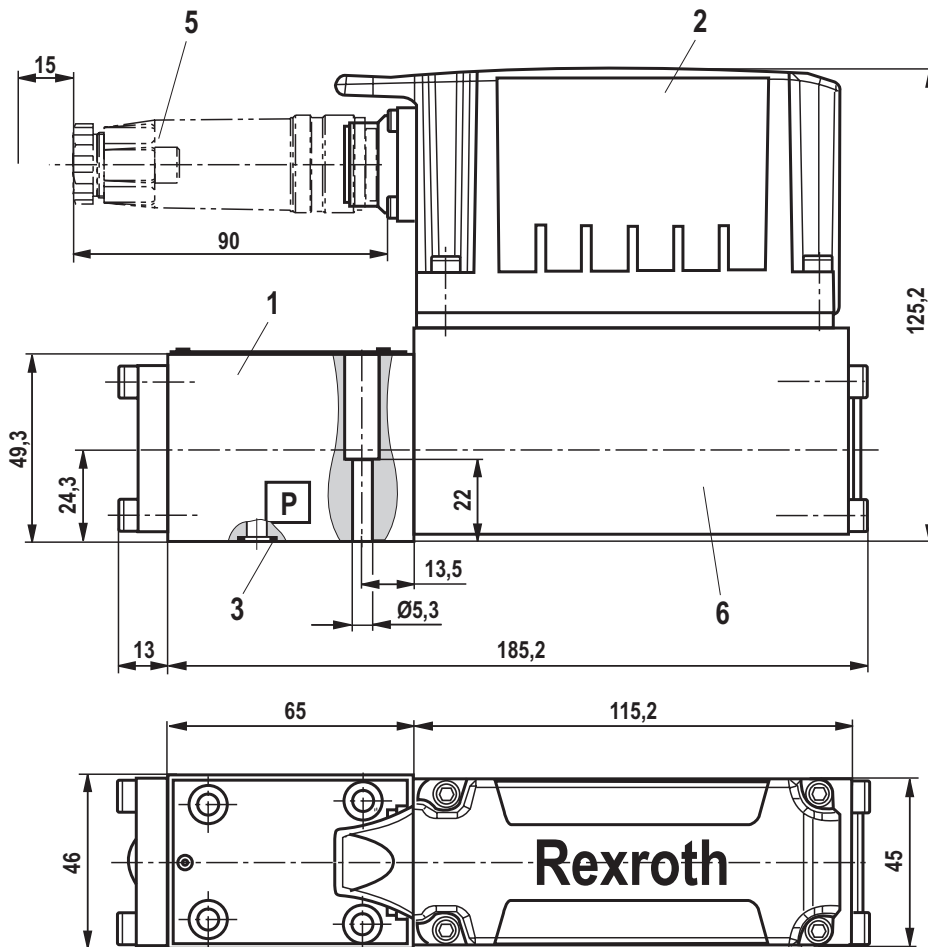

Required surface quality of the valve contact surface

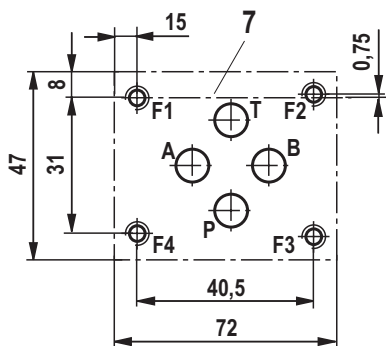

- 1 Valve housing
- 2 Integrated electronics
- 3 O-rings $\varnothing 9.25 \times 1.78$ (ports P, A, B, T)
- 4 Mating connector not included in the scope of delivery, see data sheet 08008 (separate order)
- 5 Space required to remove the mating connector
- 6 Control solenoid with position transducer
- 7 Machined valve contact surface, porting pattern according to ISO 4401-03-02-0-05
 Deviating from the standard:
 Ports P, A, B, T $\varnothing 8$ mm
 Minimum screw-in depth: Ferrous metal $1.5 \times \varnothing$
 Non-ferrous $2 \times \varnothing$

Notice!
 The dimensions are nominal dimensions which are subject to tolerances.

Dimensions

Hexagon socket head cap screws		Material number
Size 6	4x ISO 4762 - M5 x 30 - 10.9-flZn-240h-L Tightening torque $M_A = 7 \text{ Nm} \pm 10 \%$ or 4x ISO 4762 - M5 x 30 - 10.9 Tightening torque $M_A = 8.9 \text{ Nm} \pm 10 \%$	R913000316

Notice: The tightening torque of the hexagon socket head cap screws refers to maximum operating pressure.

Subplates	Data sheet	Material number
Size 6	45052	

Accessories (not included in the scope of delivery)

Mating connectors	Data sheet	Material number
Mating connector for high-response valve DIN EN 175201-804	08006	e.g. R900021267 (plastic) e.g. R900223890 (metal)

Test and service devices	Data sheet	Material number
Service case with test device for proportional servo valves with integrated electronics (OBE)	29685	

Project planning / maintenance instructions / additional information

- ▶ General operating instructions: Hydraulic valves for industrial applications, see data sheet 07600-B
- ▶ Assembly, commissioning and maintenance of hydraulic systems, see data sheet 07900
- ▶ Assembly, commissioning and maintenance of servo valves and high-response valves, see data sheet 07700
- ▶ Assembly, commissioning and maintenance of proportional valves, see data sheet 07800

Bosch Rexroth AG
Hydraulics
Zum Eisengießer 1
97816 Lohr am Main, Germany
Phone +49 (0) 93 52/ 18-0
documentation@boschrexroth.de
www.boschrexroth.de

© This document, as well as the data, specifications and other information set forth in it, are the exclusive property of Bosch Rexroth AG. It may not be reproduced or given to third parties without its consent.
The data specified above only serve to describe the product. No statements concerning a certain condition or suitability for a certain application can be derived from our information. The information given does not release the user from the obligation of own judgment and verification.
It must be remembered that our products are subject to a natural process of wear and aging.